

ZERO®

GRID

TAK/CEILING

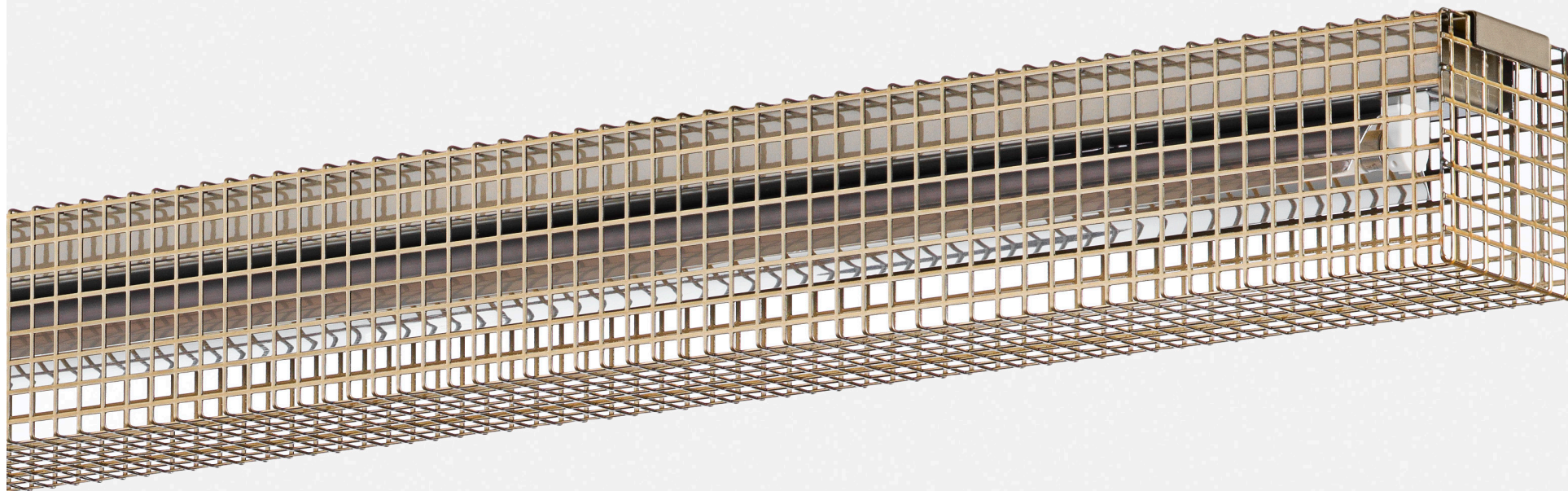

ZERO®

GRID

TAK/CEILING

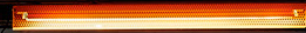
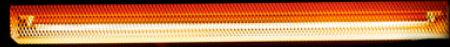
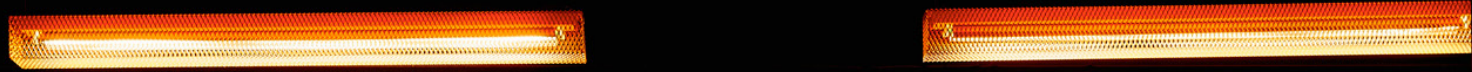

ZERO[®]**GRID**

TAK/CEILING

Utförande

Perforerad metall med kvadratiska hål alt. sträckmetall.
Lackerad gul RAL 1018, orange RAL 2004, klarlackerad metall alt. transparent guldlack. Grid har ett rått uttryck och man kan se svetsfogar mm genom den transparenta lacken. Andra färger på förfrågan.

LED info

Systemeffekt 19W, 33W. Armaturlumen 1414LM, 2210LM. Korrelerad färgtemperatur 3000K, 4000K. Färgtolerans SDCM 3. Färgåtergivning RA 80. L 80 58.000H.

Montage

I tak.

Anslutning

Snabb-kopplingsplint 5x4mm².

Design

Front 2011

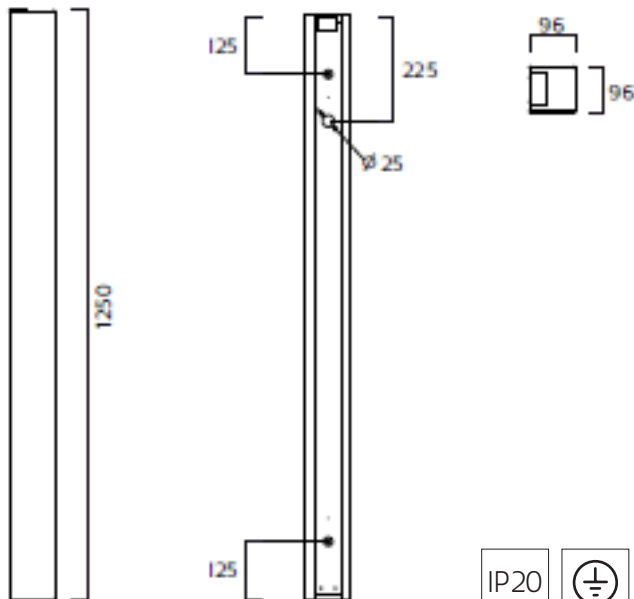
**Finish**

Perforated metal with square holes or expanded metal. Yellow RAL 1018, orange RAL 2004, clear painted metal or transparent gold varnish. Grid has a raw finish and one can see weldings through the transparent varnish. Other colours on request.

LED info

System power 19W or 33W. Luminaire Luminous Flux 1414LM or 2210LM. CCT 3000K, 4000K. SDCM 3. CRI 80. L80 58.000H.

Installation

In ceiling.

Connection

Terminal block 5x4mm².

Design

Front 2011

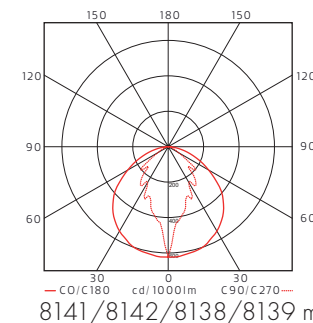
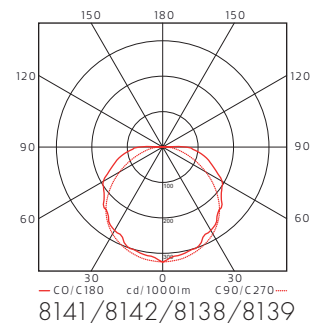



GRID

TAK/CEILING

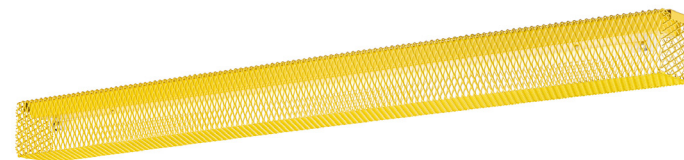

PRODUKTFAKTA/PRODUCT SPECIFICATION

EFFEKT/POWER	KELVIN	CRI	MODELL/MODEL	FÄRG/COLOUR	ART.
LED 3000K					
1414LM/19W	3000K	>80	Fyrkantshål/Square holes	Gul/Yellow	8141-1-14
1414LM/19W	3000K	>80	Fyrkantshål/Square holes	Gul/Yellow	8141-1-14HFF
1414LM/19W	3000K	>80	Fyrkantshål/Square holes	Orange/Orange	8141-1-41
1414LM/19W	3000K	>80	Fyrkantshål/Square holes	Orange/Orange	8141-1-41HFF
1414LM/19W	3000K	>80	Fyrkantshål/Square holes	Metall/Metal	8141-1-76
1414LM/19W	3000K	>80	Fyrkantshål/Square holes	Metall/Metal	8141-1-76HFF
1414LM/19W	3000K	>80	Fyrkantshål/Square holes	Guld/Gold	8141-1-77
1414LM/19W	3000K	>80	Fyrkantshål/Square holes	Guld/Gold	8141-1-77HFF
1414LM/19W	3000K	>80	Streckmetall/Expanded metal	Gul/Yellow	8142-1-14
1414LM/19W	3000K	>80	Streckmetall/Expanded metal	Gul/Yellow	8142-1-14HFF
1414LM/19W	3000K	>80	Streckmetall/Expanded metal	Orange/Orange	8142-1-41
1414LM/19W	3000K	>80	Streckmetall/Expanded metal	Orange/Orange	8142-1-41HFF
1414LM/19W	3000K	>80	Streckmetall/Expanded metal	Metall/Metal	8142-1-76
1414LM/19W	3000K	>80	Streckmetall/Expanded metal	Metall/Metal	8142-1-76HFF
1414LM/19W	3000K	>80	Streckmetall/Expanded metal	Guld/Gold	8142-1-77
1414LM/19W	3000K	>80	Streckmetall/Expanded metal	Guld/Gold	8142-1-77HFF
2210LM/33W	3000K	>80	Fyrkantshål/Square holes	Gul/Yellow	8138-1-14
2210LM/33W	3000K	>80	Fyrkantshål/Square holes	Gul/Yellow	8138-1-14HFF
2210LM/33W	3000K	>80	Fyrkantshål/Square holes	Orange/Orange	8138-1-41
2210LM/33W	3000K	>80	Fyrkantshål/Square holes	Orange/Orange	8138-1-41HFF
2210LM/33W	3000K	>80	Fyrkantshål/Square holes	Metall/Metal	8138-1-76
2210LM/33W	3000K	>80	Fyrkantshål/Square holes	Metall/Metal	8138-1-76HFF
2210LM/33W	3000K	>80	Fyrkantshål/Square holes	Guld/Gold	8138-1-77
2210LM/33W	3000K	>80	Fyrkantshål/Square holes	Guld/Gold	8138-1-77HFF

HFF = Dimbar DALI, SwitchDim/HFF = Dimmable DALI or SwitchDim

Tabellen fortsätter på nästa sida/Specification continues on next page -

ZERO®**GRID**

TAK/CEILING

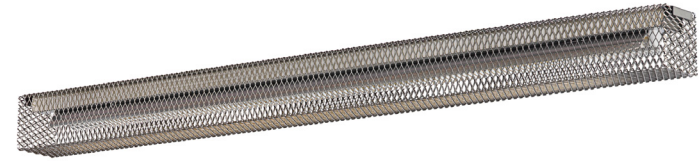

PRODUKTFAKTA/PRODUCT SPECIFICATION

EFFEKT/POWER	KELVIN	CRI	MODELL/MODEL	FÄRG/COLOUR	ART.
LED 3000K					
2210LM/33W	3000K	>80	Streckmetall/Expanded metal	Gul/Yellow	8139-1-14
2210LM/33W	3000K	>80	Streckmetall/Expanded metal	Gul/Yellow	8139-1-14HFF
2210LM/33W	3000K	>80	Streckmetall/Expanded metal	Orange/Orange	8139-1-41
2210LM/33W	3000K	>80	Streckmetall/Expanded metal	Orange/Orange	8139-1-41HFF
2210LM/33W	3000K	>80	Streckmetall/Expanded metal	Metall/Metal	8139-1-76
2210LM/33W	3000K	>80	Streckmetall/Expanded metal	Metall/Metal	8139-1-76HFF
2210LM/33W	3000K	>80	Streckmetall/Expanded metal	Guld/Gold	8139-1-77
2210LM/33W	3000K	>80	Streckmetall/Expanded metal	Guld/Gold	8139-1-77HFF
TILLBEHÖR/ACCESSORIES					ART.
Reflektor LED/Reflector LED					98126-1-82
HFF = Dimbar DALI, SwitchDim/HFF = Dimmable DALI or SwitchDim			Tabellen fortsätter på nästa sida/Specification continues on next page -		

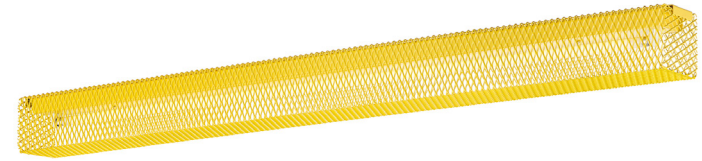

GRID

TAK/CEILING



PRODUKTFAKTA/PRODUCT SPECIFICATION

EFFEKT/POWER	KELVIN	CRI	MODELL/MODEL	FÄRG/COLOUR	ART.
LED 4000K					
1555LM/19W	4000K	>80	Fyrkantshål/Square holes	Gul/Yellow	8141-1-14-40
1555LM/19W	4000K	>80	Fyrkantshål/Square holes	Gul/Yellow	8141-1-14D40
1555LM/19W	4000K	>80	Fyrkantshål/Square holes	Orange/Orange	8141-1-41-40
1555LM/19W	4000K	>80	Fyrkantshål/Square holes	Orange/Orange	8141-1-41D40
1555LM/19W	4000K	>80	Fyrkantshål/Square holes	Metall/Metal	8141-1-76-40
1555LM/19W	4000K	>80	Fyrkantshål/Square holes	Metall/Metal	8141-1-76D40
1555LM/19W	4000K	>80	Fyrkantshål/Square holes	Guld/Gold	8141-1-77-40
1555LM/19W	4000K	>80	Fyrkantshål/Square holes	Guld/Gold	8141-1-77D40
1555LM/19W	4000K	>80	Streckmetall/Expanded metal	Gul/Yellow	8142-1-14-40
1555LM/19W	4000K	>80	Streckmetall/Expanded metal	Gul/Yellow	8142-1-14D40
1555LM/19W	4000K	>80	Streckmetall/Expanded metal	Orange/Orange	8142-1-41-40
1555LM/19W	4000K	>80	Streckmetall/Expanded metal	Orange/Orange	8142-1-41D40
1555LM/19W	4000K	>80	Streckmetall/Expanded metal	Metall/Metal	8142-1-76-40
1555LM/19W	4000K	>80	Streckmetall/Expanded metal	Metall/Metal	8142-1-76D40
1555LM/19W	4000K	>80	Streckmetall/Expanded metal	Guld/Gold	8142-1-77-40
1555LM/19W	4000K	>80	Streckmetall/Expanded metal	Guld/Gold	8142-1-77D40
2430LM/33W	4000K	>80	Fyrkantshål/Square holes	Gul/Yellow	8138-1-14-40
2430LM/33W	4000K	>80	Fyrkantshål/Square holes	Gul/Yellow	8138-1-14D40
2430LM/33W	4000K	>80	Fyrkantshål/Square holes	Orange/Orange	8138-1-41-40
2430LM/33W	4000K	>80	Fyrkantshål/Square holes	Orange/Orange	8138-1-41D40
2430LM/33W	4000K	>80	Fyrkantshål/Square holes	Metall/Metal	8138-1-76-40
2430LM/33W	4000K	>80	Fyrkantshål/Square holes	Metall/Metal	8138-1-76D40
2430LM/33W	4000K	>80	Fyrkantshål/Square holes	Guld/Gold	8138-1-77-40
2430LM/33W	4000K	>80	Fyrkantshål/Square holes	Guld/Gold	8138-1-77D40

HFF = Dimbar DALI, SwitchDim/HFF = Dimmable DALI or SwitchDim

Tabellen fortsätter på nästa sida/Specification continues on next page -



GRID

TAK/CEILING

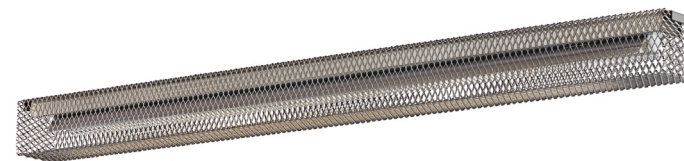

PRODUKTFAKTA/PRODUCT SPECIFICATION

EFFEKT/POWER	KELVIN	CRI	MODELL/MODEL	FÄRG/COLOUR	ART.
LED 4000K					
2430LM/33W	4000K	>80	Streckmetall/Expanded metal	Gul/Yellow	8139-1-14-40
2430LM/33W	4000K	>80	Streckmetall/Expanded metal	Gul/Yellow	8139-1-14D40
2430LM/33W	4000K	>80	Streckmetall/Expanded metal	Orange/Orange	8139-1-41-40
2430LM/33W	4000K	>80	Streckmetall/Expanded metal	Orange/Orange	8139-1-41D40
2430LM/33W	4000K	>80	Streckmetall/Expanded metal	Metall/Metal	8139-1-76-40
2430LM/33W	4000K	>80	Streckmetall/Expanded metal	Metall/Metal	8139-1-76D40
2430LM/33W	4000K	>80	Streckmetall/Expanded metal	Guld/Gold	8139-1-77-40
2430LM/33W	4000K	>80	Streckmetall/Expanded metal	Guld/Gold	8139-1-77D40

D40 = Dimbar DALI, SwitchDim D40 = Dimmable DALI or SwitchDim

TILLBEHÖR/ACCESSORIES

	ART.
Reflektor LED/Reflector LED	98126-1-82

ZERO®

GRID

TAK/CEILING



FRONT DESIGN

Sofia Lagerkvist och Anna Lindgren utgör den svenska designgruppen Front.

Deras verk baseras på gemensamma diskussioner, utforskningar och experiment och de är inblandade i projekten från idéskiss till slutprodukt.

Fronts designobjekt kommunicerar ofta en historia till observatören om designprocessen, materialet produkten är tillverkad av, och/eller om konventioner inom designområdet. I sitt arbete har de tilldelat en del av designen till djuren, datorerna eller maskinerna.

De har gjort en ständigt föränderligt interiör, skapat föremål med explosioner, robotmöbler och en rad möbler inspirerade av deras fascination med magi.

Photo: Toni Meneguzzo

Sofia Lagerkvist and Anna Lindgren are the members of the Swedish design group Front. Their works are based on common discussions, explorations and experiments and they are all involved in the projects from initial ideas to the final product.

Front's design objects often communicate a story to the observer about the design process, about the material it is made of or about conventions within the design field. In their work they have assigned part of the making of design to animals, computers or machines.

They have made a constantly changing interior, created objects with explosions, robotic furniture and a range of furniture inspired by their fascination with magic.

ZERO[®]

GRID

TAK/CEILING

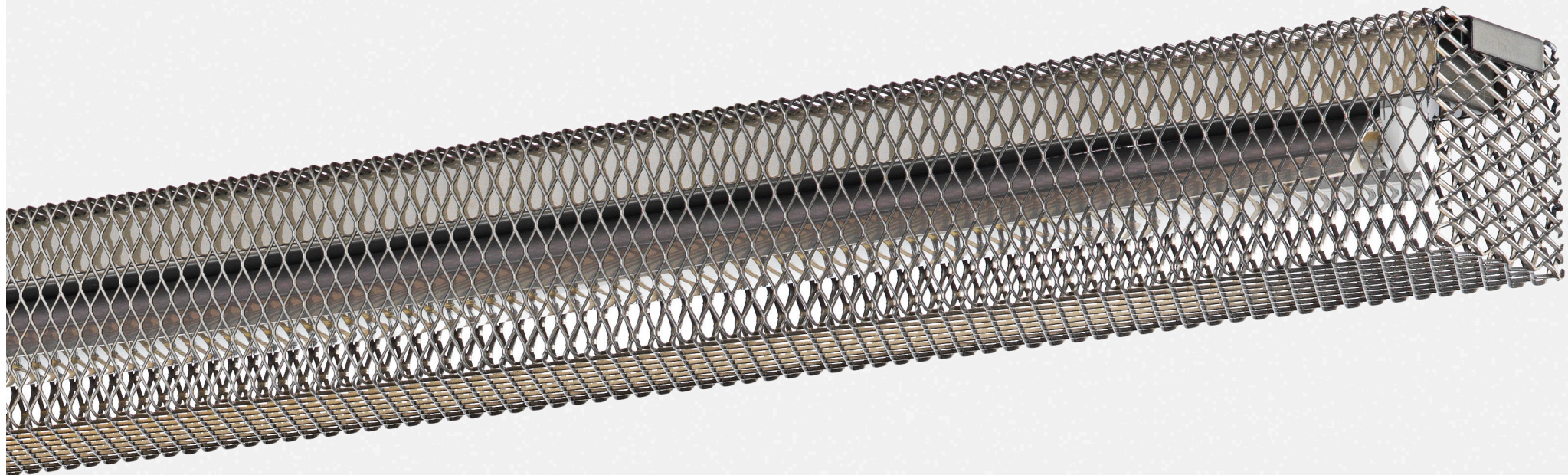

Head office:
Friluftsvägen 2
SE-382 31 Nybro, Sweden
+46(0)481 800 00
info@zero.se

Showroom Stockholm:
Södermalmsallén 36,
SE-118 28 Stockholm, Sweden
+46(0)8-545 850 00

info@zero.se